

**LITON**

# 立敦科技公司簡介

報告人：行政管理處 王國權

日期：2022/08/15



LITON

# 公司概況

LITON

創立時間：1993年11月

資本額：新台幣14.32億元

董事長：吳德銓先生

總經理：柯村忭先生

員工人數：約 400人

生產廠區：台灣苗栗廠、廣東惠州廠、  
四川阿壩州廠、廣東乳源廠

經營理念：品質、創新、服務、責任

# 立敦科技產品

LITON

- 低、中、高壓電蝕箔
- 低、中、高壓化成箔
- 引出條

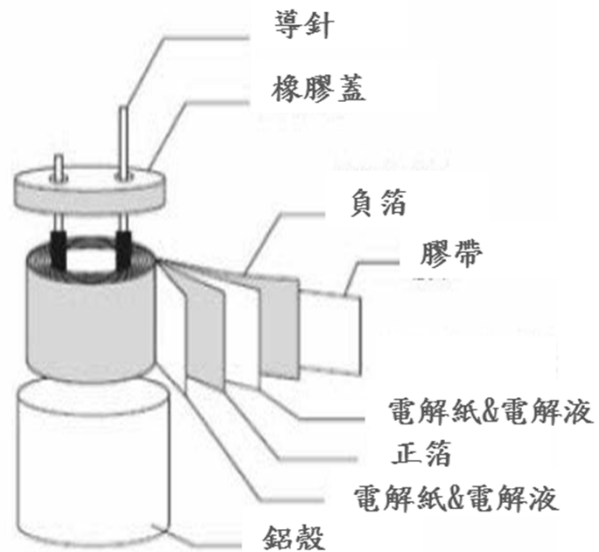
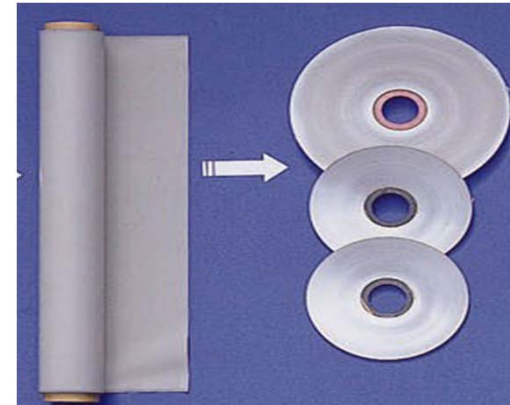

# 公司產品應用

LITON



## 車用電子

ECU、儀表板、車用穩壓器、  
LED車燈、安全裝置...

## 生醫、醫療器材

輔助呼吸器、醫療檢驗設備...

## 資通訊

無線通訊、主機板、伺服器、  
5G、行動基地台...

## 重工、運輸

高鐵、捷運、機械人、工業用設備...

## 綠能環保

風力、太陽能發電...

## 其他

消費性電子、儲能轉換裝置..



# 公司沿革(1/2)

LITON

- 1993年 11月 成立「立敦電機股份有限公司」。
- 1994年 1月 苗栗廠自日本引進低壓化成鋁箔技術與設備。
- 1995年 6月 苗栗廠投產。  
7月 與工研院材料所簽訂「中長期化成鋁箔技術合作計劃」。
- 1998年 5月 更名為「立敦科技股份有限公司」。
- 1999年 7月 取得SGS ISO 9001品質管理系統認證。  
12月 經濟部投審會核准大陸投資，惠州建廠。
- 2000年 4月 公開發行並委請大華證券上櫃輔導。  
9月 榮獲天下雜誌評選為全國100大成長最快中堅企業之第13名。
- 2001年 1月 取得SGS ISO 14001 環境管理系統認證。  
10月 惠州廠投產。
- 2002年 1月 證期會核准股票上櫃。  
6月 股票正式掛牌。
- 2003年 11月 併購同業永剛科技，建構多元技術及產品。

## 公司沿革(2/2)

LITON

- 2009年 9月 汶川大地震後災後重建，漩口新型工業園區建廠。
- 2010年 10月 阿壩州廠(漩口)投產。
- 2012年 9月 併購全用電子工業，高純度導針產品加入營運。
- 2015年 1月 引進日本松下電蝕技術與設備，同時與中國東陽光科合資成立「乳源立東電子科技」，生產低、中、高壓電蝕鋁箔。
- 2016年 6月 立東電子取得AFNOR ISO 9001 & ISO 14001管理系統認證。  
6月 營運連續性計畫(BCP)制定。
- 2017年 5月 企業社會責任(SCR)宣示。  
10月 導入全球首創【AI人工智慧箔面瑕疵檢測系統】。
- 2020年 2月 惠州廠取得 IATF-16949(2016)汽車產業品質管理系統認證。  
7月 責任商業聯盟(RBA)宣示。

# 全面品質管理(TQM)



ISO 9001 : 2015

ISO 14001 : 2015



工業技術研究院  
Industrial Technology  
Research Institute

「中長期化成鋁箔技術合作計畫」



Zero Defect



International  
Automotive  
Task Force

**IATF 16949(2016)**  
汽車產業品質管理系統認證



**FTA**

# 立敦科技集團

LITON

立敦科技  
(總公司)

立敦科技股份有限公司 (苗栗工廠)

-1993

立敦電子科技(惠州)有限公司

-1999

立敦電子科技(阿壩州)有限公司

-2009

乳源縣立東電子科技有限公司

-2015



# 組織架構

LITON

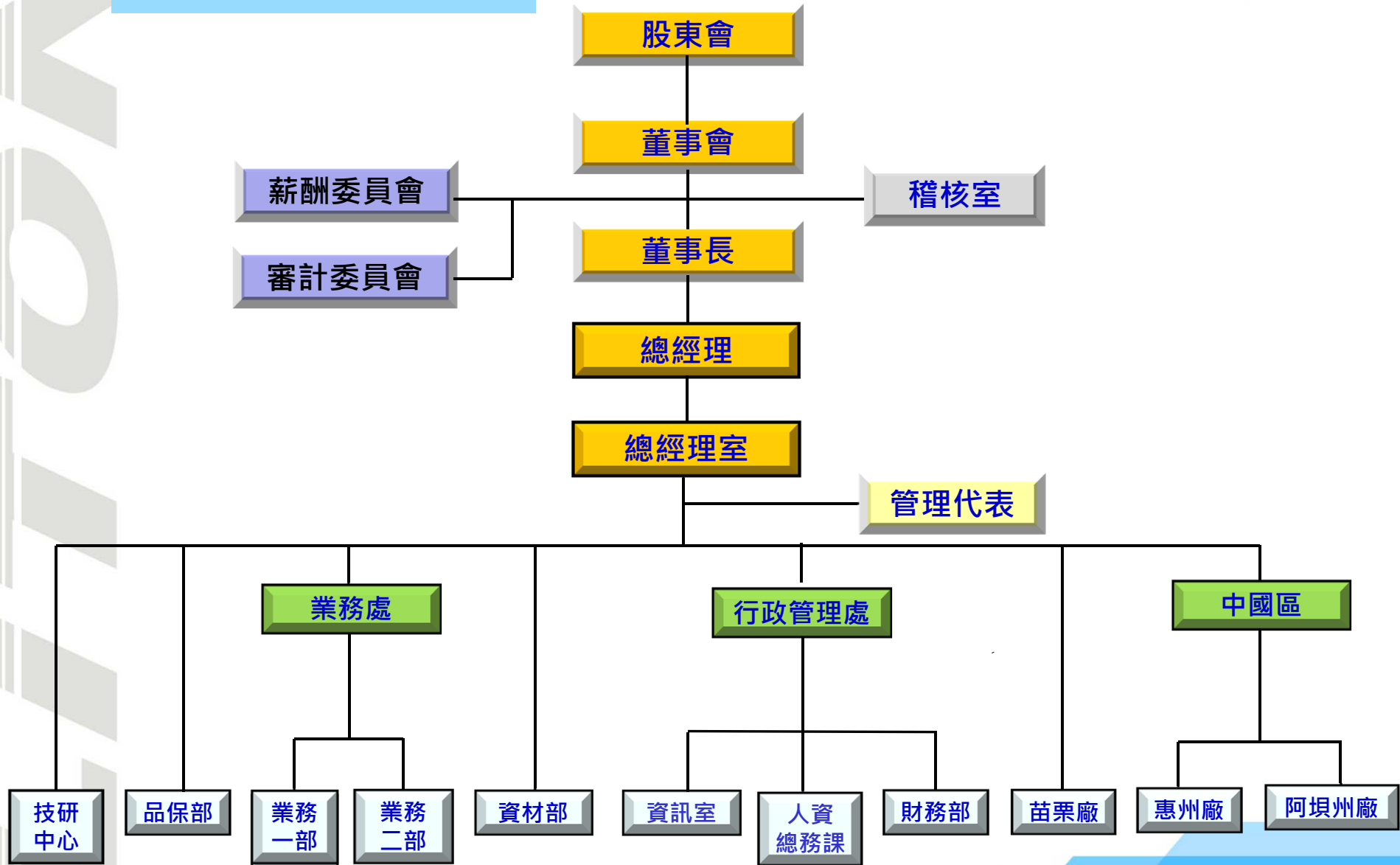

# 立敦科技集團版圖

LITON



# 合併營收

LITON

單位:新台幣千元

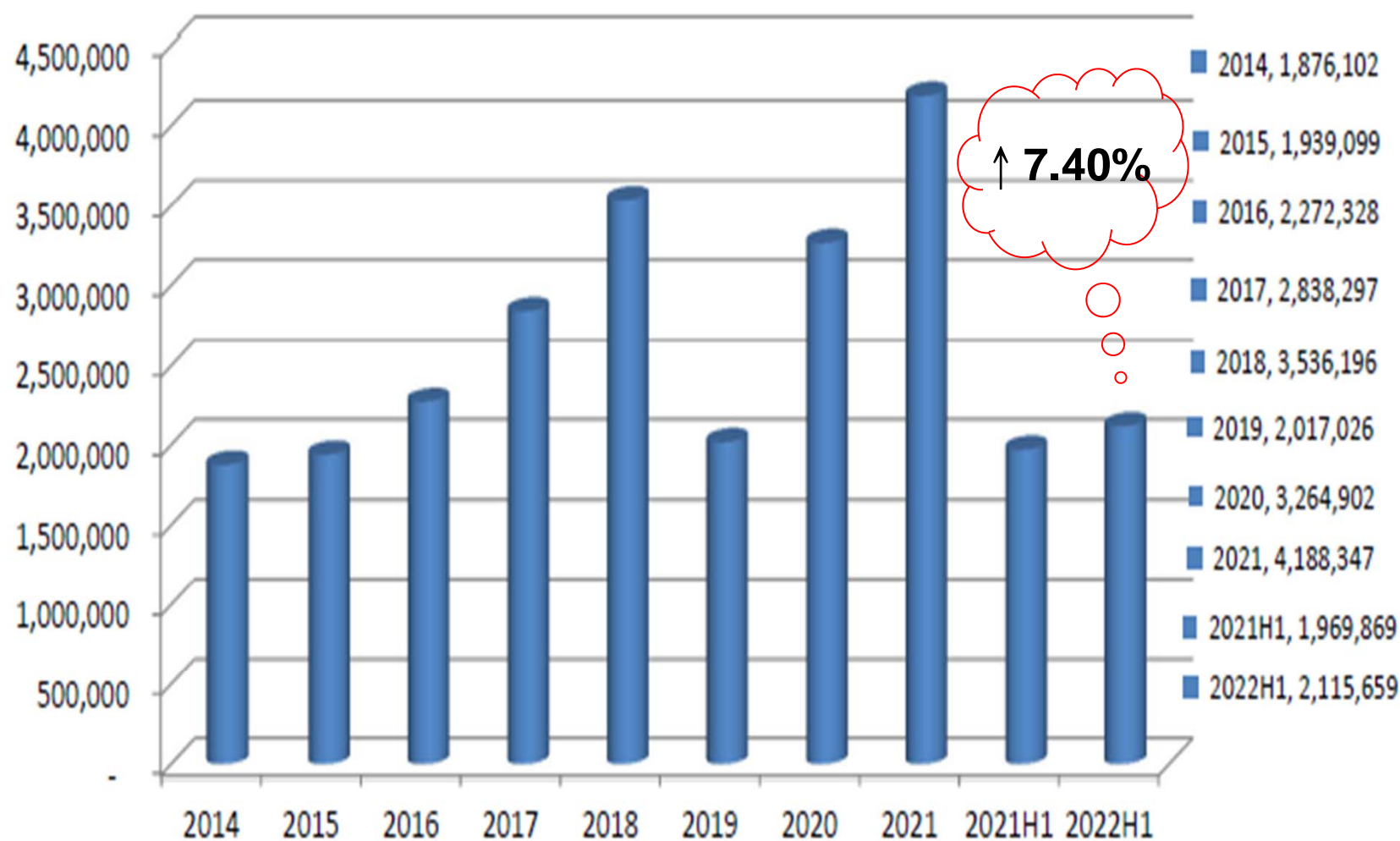

# 客戶分佈

LITON

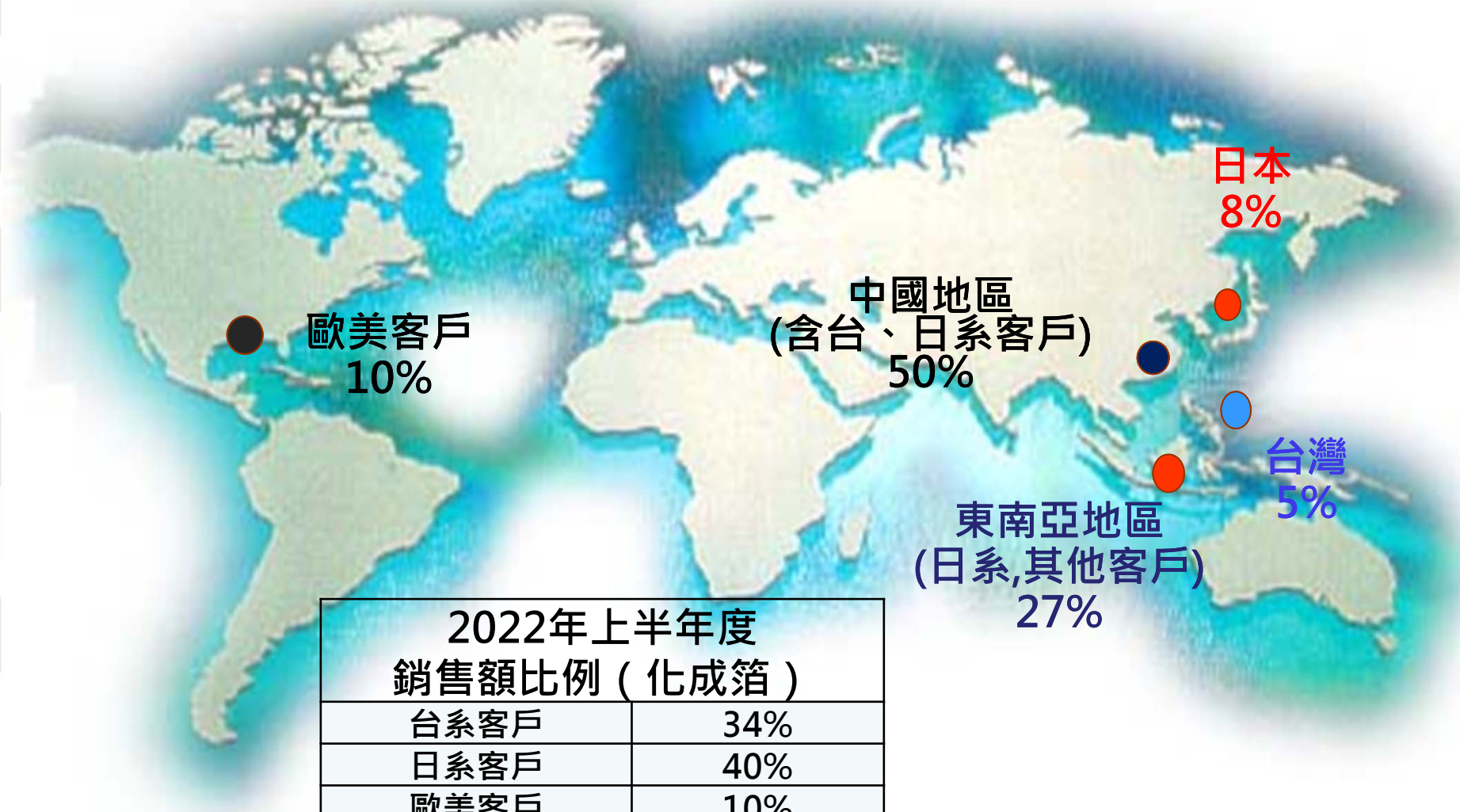

2022年上半年度 銷售額比例 (化成箔)	
台系客戶	34%
日系客戶	40%
歐美客戶	10%
陸系客戶	15%
其他客戶	1%

# 財務資訊

LITON

單位:新台幣千元

	2020年度	2021年度	2021H1	2022H1
合併營收	3,264,902	4,188,347	1,969,869	2,115,659
腐蝕箔	983,314	1,244,826	572,972	651,677
化成箔	2,147,564	2,783,135	1,309,101	1,432,085
其他	134,024	160,386	87,793	31,897
成長率	12%	28%	27%	7%
稅後淨利	274,559	486,680	233,250	278,528
EPS(元)	2.02	3.45	1.67	1.95

**THANK YOU !**



❖ 總公司及苗栗工廠-(1993建置)

LITON



低壓化成箱



❖ 立敦惠州公司-(1999建置)

LITON



低壓化成箔





## ❖ 立敦阿壩州公司-(2009建置)

LITON



低、中、高壓化成箔及引出條



## ❖ 廣東乳源立東公司-(2015建置)

LITON



低、中、高壓電蝕箔





**LITON**

# **LITON TECHNOLOGY CORP.**

## **Company profile**

presented by  
Wang Roger  
Administration Director

Date : 2022/08/15



## Company Overview

**LITON**

- Established : Nov. 1993
- Capital : NTD 1.43 billion
- Chairman : Mr. T.C.Wu
- CEO : Mr. Steve T.H.Ko
- Employee : around 400 members
- Factories : **LITON Technology Miao-Li Factory (Taiwan)**  
LITON Electronics (Hui-Zhou) (China)  
LITON Electronics (A BA-Zhou) (China)  
**LIDON Technology Corp.(China)**
- Business Concept : Quality 、 Innovation 、  
Service 、 Responsibility

# LITON Products

- Etched Foils
- Formed Foils
- TAB Foils

**LITON**

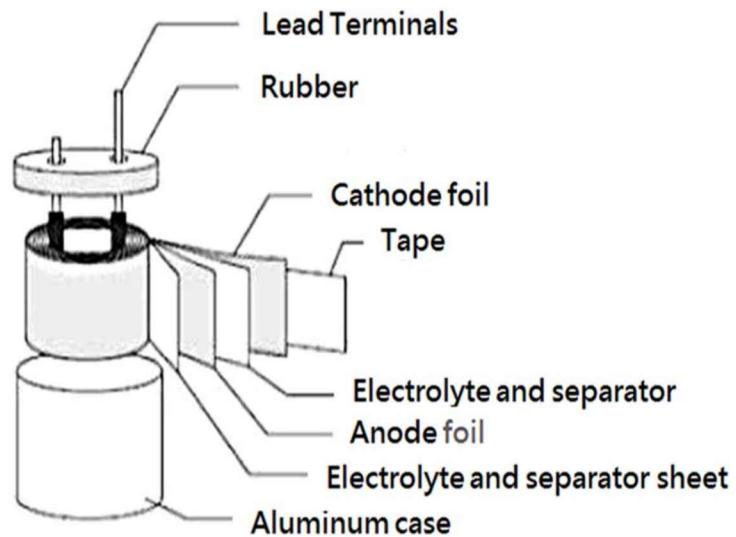
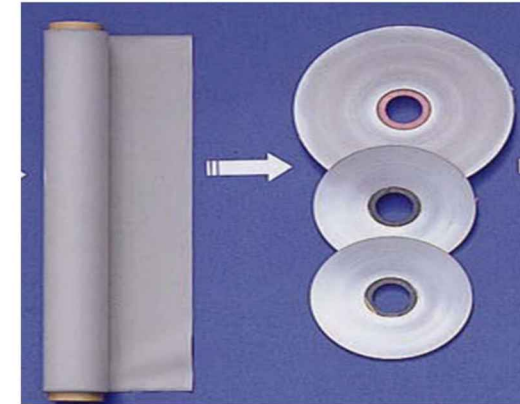

# Product applications

**LITON**



**Automotive applications**  
(Dashboard, Car stabilizer, Head up display, LED headlight, Airbag ...)

**Medical Devices**  
(Ventilator, medical laboratory technology ...)

**Communication products**  
(Telephone, Fax machine, 5G, Wireless communication ...)

**Heavy industry and transportations**  
(High speed train, MRT, robot and industrial equipment ...)

**Environmental generating devices** (Wind and Solar power generation ...)

**The others**  
(Measuring tools, Aviation, National defense ...)



## Major Events(1)

**LITON**

- 1993 Nov. “LITON Electric Corp.” was found with a startup capital of NTD 26 million in Miao-Li Taiwan.
- 1994 Jan. Transferred first Low Voltage Formed Production Line & technical from Japan.
- 1995 Jun. Miao-Li Factory the 1<sup>st</sup> Low Voltage formed Production Line was Operated.  
Jul. Technical support from Materials Research Laboratories of ITRI for Aluminum Formed Foils with technical cooperation projects.
- 1998 May Changed the company name to “LITON Technology Corp”
- 1999 Jul. Received SGS ISO9001 certification.  
Dec. INVESTMENT COMMISSION, MOEA approve China investment, established Huizhou factory.
- 2000 Apr. LITON'S stock officially issued in the stock market.  
Sep. Listed in the "TOP 100 Developing enterprises in Taiwan ranked the 13th by "common wealth" magazine.

## Major Events(2)

**LITON**

- 2001 Jan. Received SGS ISO14001 certification.  
Oct. Operated in Huizhou factory
- 2002 Jan. Listed in OTC.  
Jun. LITON's stocks were public offering on OTC (Gre Tai Securities Market) in Taiwan.
- 2003 Nov. LITON merged ECHO, developing diversify technology and product.
- 2009 Sep. Rebuilding plan after Wenchuan earthquake, factory moved to Xuankou New industrial park and installed first stage.
- 2010 Oct. A BA-Zhou (Xuankou, Sichuan) factory started operation.
- 2012 Sep. Merged GENENIC Hui-Dong factory to develop lead-wire manufacture.
- 2015 Jan. Introduced technology and equipment from Panasonic Japan, established joint venture "LIDON TECHNOLOGY CORP.." (Guangdong) with HEC for etching foil production.



## Major Events(3)

**LITON**

- 2016 Jun. LIDON certified by AFNOR ISO9001& ISO14001.  
Jun. Established Business Continuity Plan
- 2017 May. Declaration of corporate social responsibility  
Oct. Pioneer in **【Artificial intelligence inspect foil defection system】**  
to production lines.
- 2020 Feb. Received IATF-16949(2016) certification.  
Jul. Declaration of Responsible Business Alliance.

# Total Quality Management (TQM)



**ITRI**  
Industrial Technology  
Research Institute

Medium and Long-Term  
Technology Cooperation Plan  
of Aluminum Formed Foil

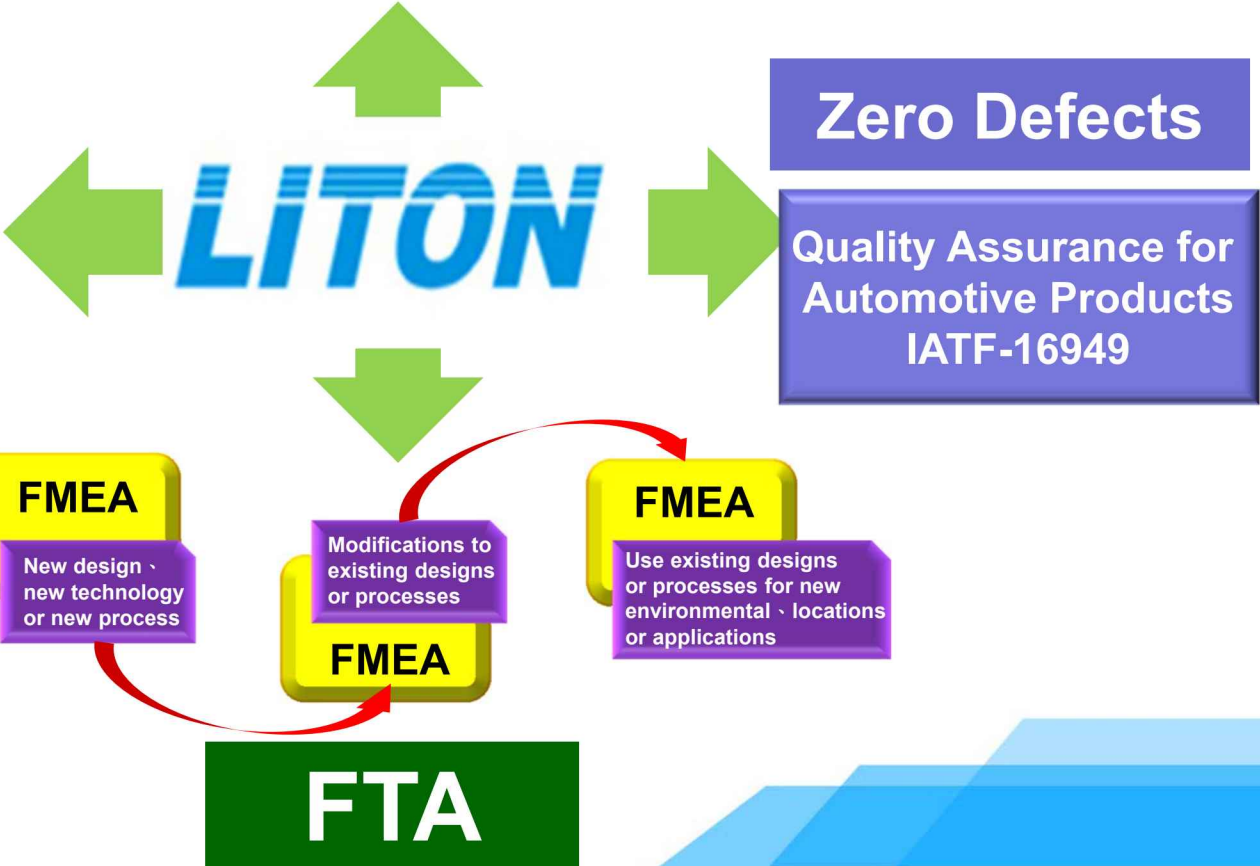

# LITON Technology and Factories

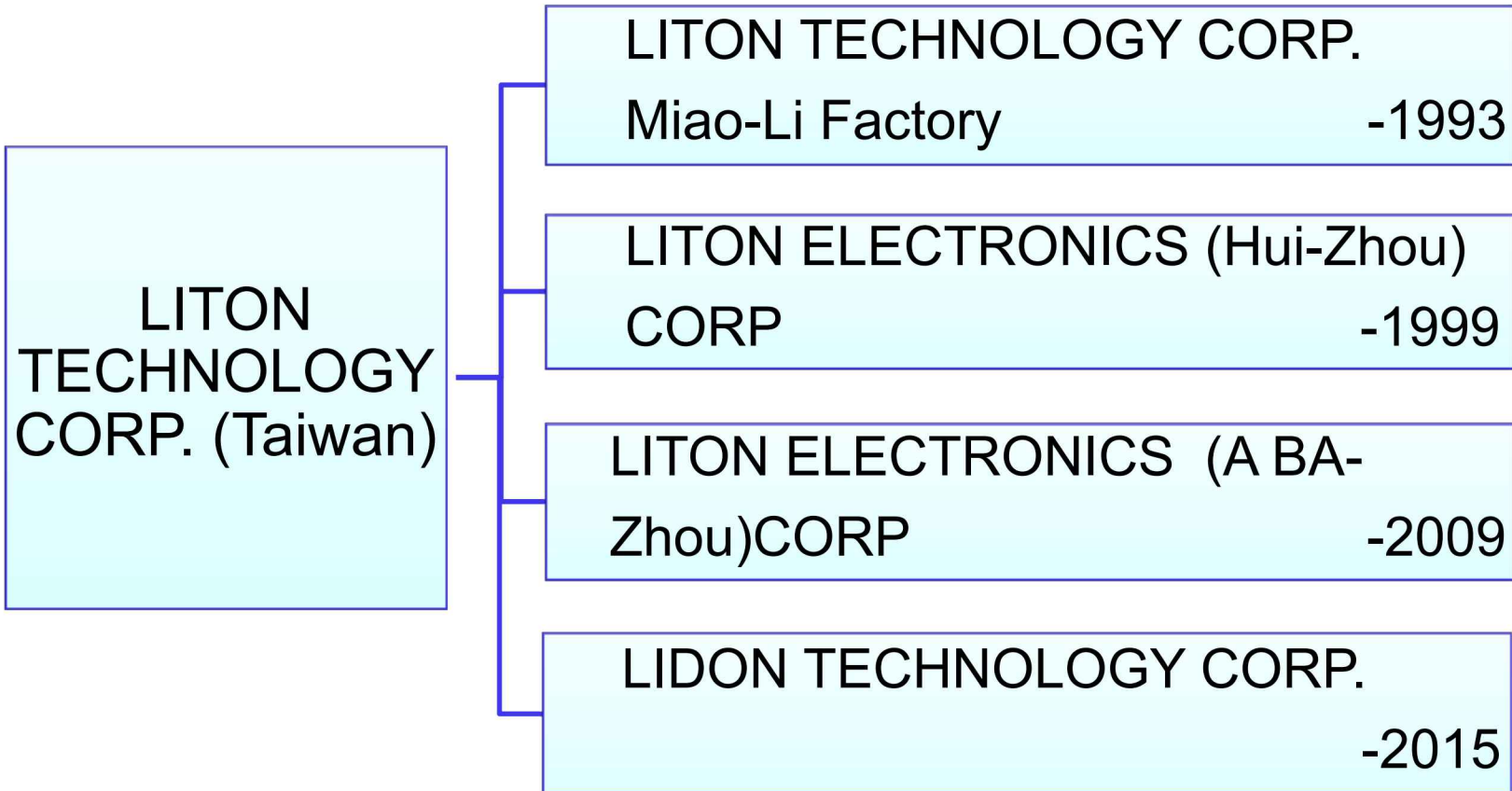

# Organization Chart

**LITON**

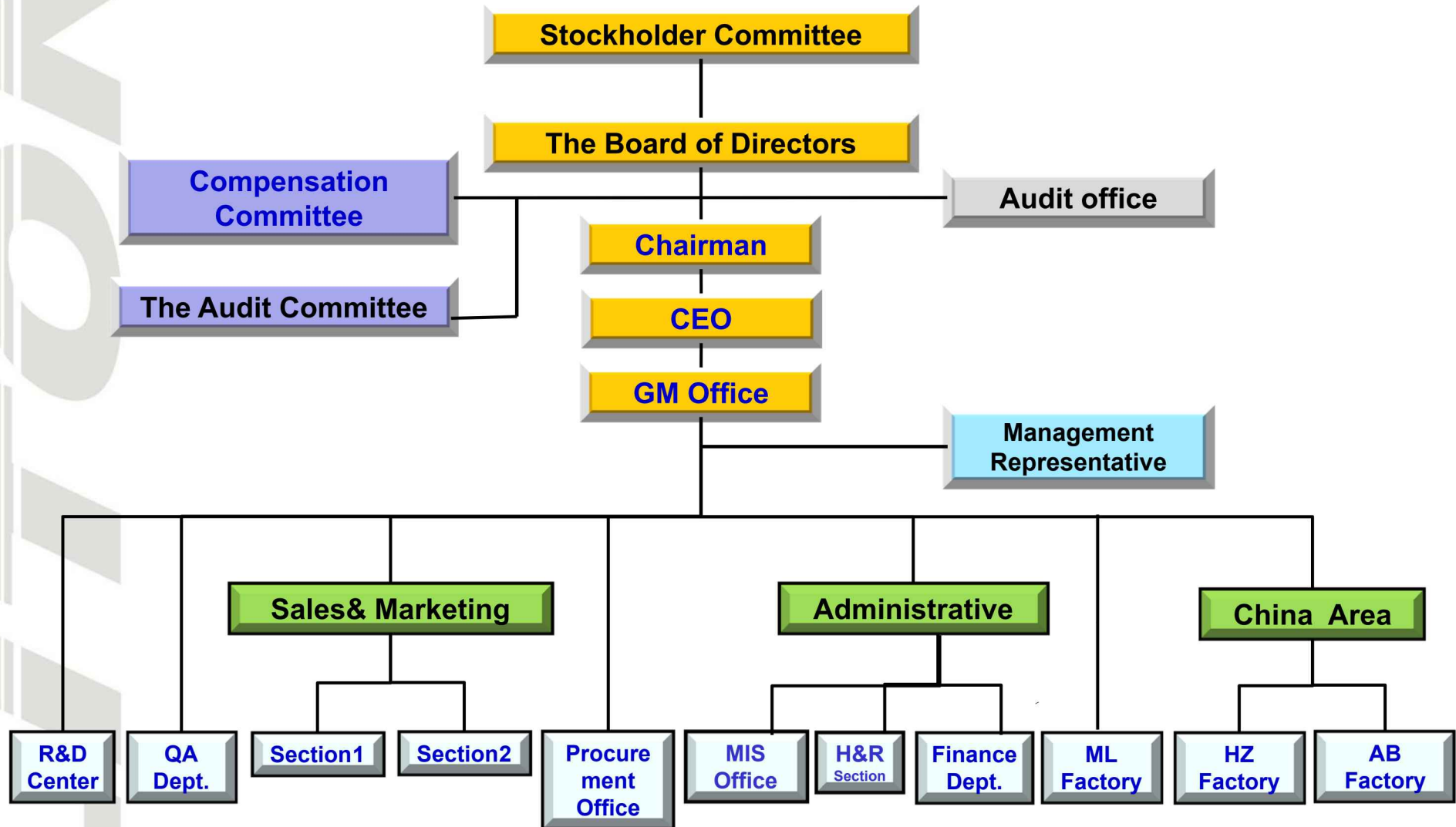

# Facilities Location

**LITON**



# Sales Revenue

**LITON**

Unit : NT\$ thousand

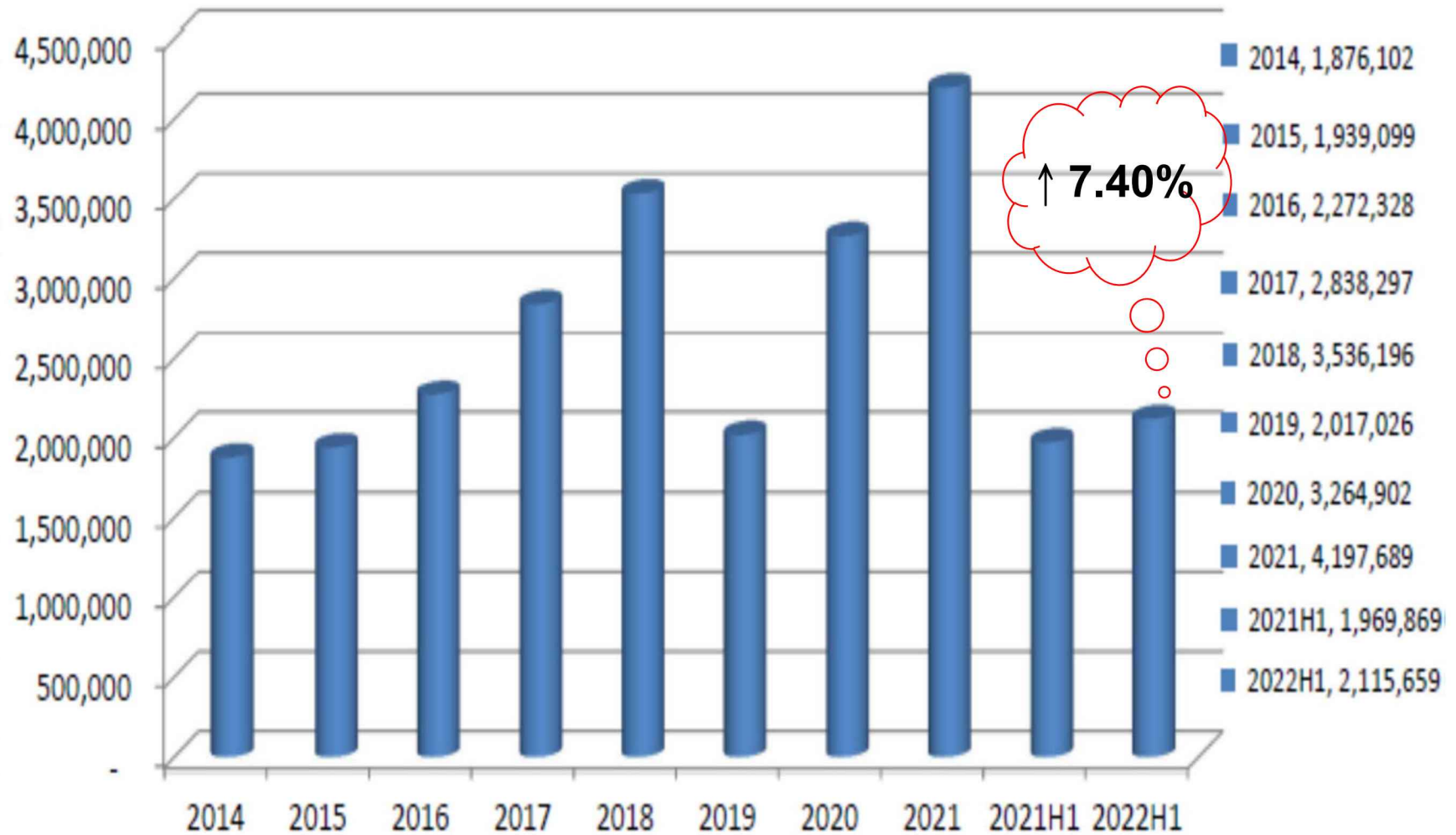

# Sales Distribution

**LITON**

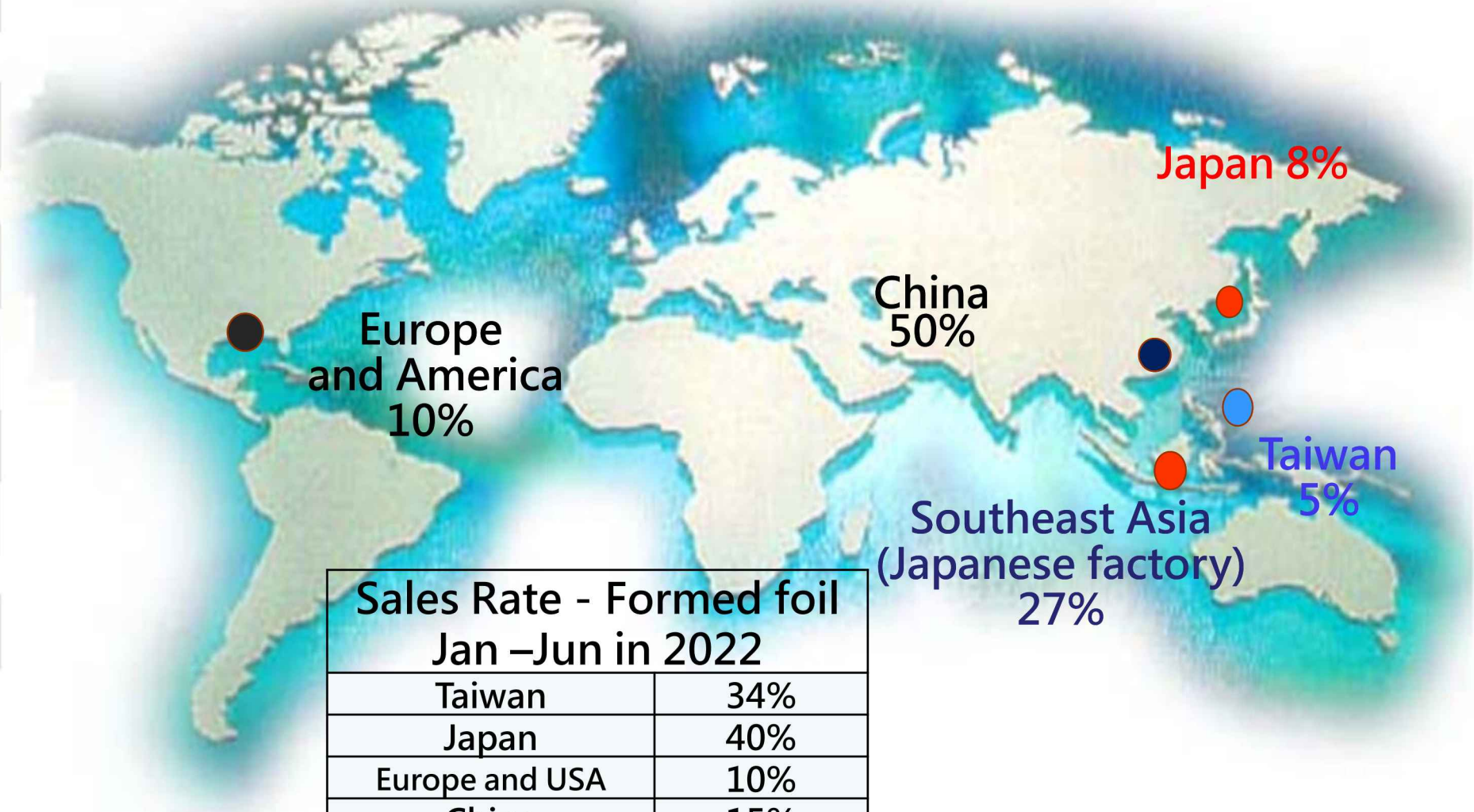

Sales Rate - Formed foil Jan –Jun in 2022	
Taiwan	34%
Japan	40%
Europe and USA	10%
China	15%
The others	1%

# Financial information



Unit : NT\$ thousand

	2020	2021	2021H1	2022H1
Consolidated revenue	3,264,902	4,188,347	1,969,869	2,115,659
Etched foil	983,314	1,244,826	572,972	651,677
Formed foil	2,147,564	2,783,135	1,309,101	1,432,085
Others	134,024	160,386	87,793	31,897
Grow rate	12%	28%	27%	7%
Post-tax Net profit	274,559	486,680	233,250	278,528
EPS (Dollar)	2.02	3.45	1.67	1.95



**THANK YOU !**



❖ Corporate Headquarters & LITON  
Miao-Li, Since 1993

**LITON**



Low voltage forming foils



❖ LITON Hui-Zhou, Since 1999

**LITON**



Low voltage forming foils



❖ LITON ABA-Zhou, Since 2009

**LITON**



Low/Mid/ High voltage forming foils & Lead TABs



❖ LIDON Ruyuan, Since 2015

**LITON**



Low/mid/High voltage etching foils

